



Flying Bird

Model 6

Source : Plan et images de LEGO Education, sans le +
Modification et bonification des plans par le Service national du RÉCIT à l'éducation préscolaire
Translation: LEARN-RÉCIT
February 2011



1 brick 8 X 16
1 USB Hub



1

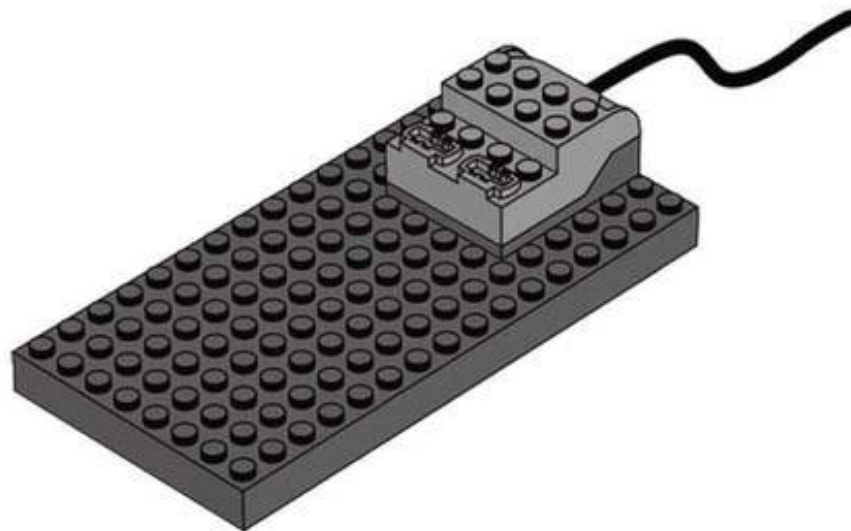

2

1 yellow brick
2 X 6
2 plates
2 X 4

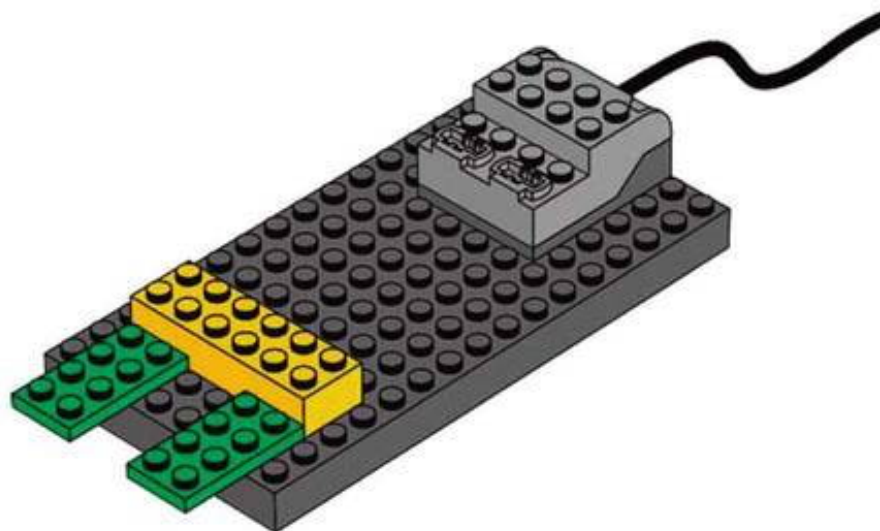
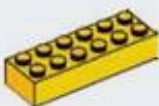

2 green round bricks
2 X 2



2 axes, 8-module



3

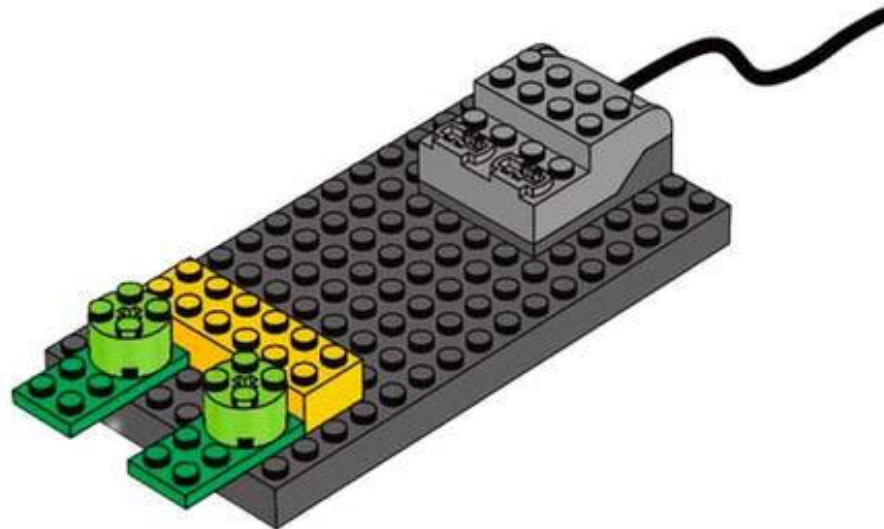

4

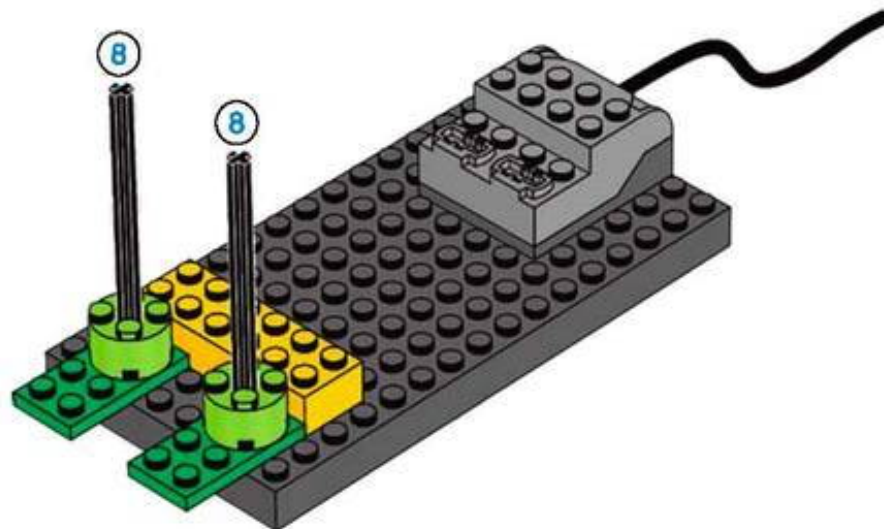

2 crown gears
24-tooth



1 red brick
2 X 6



2 round bricks
2 X 2



5

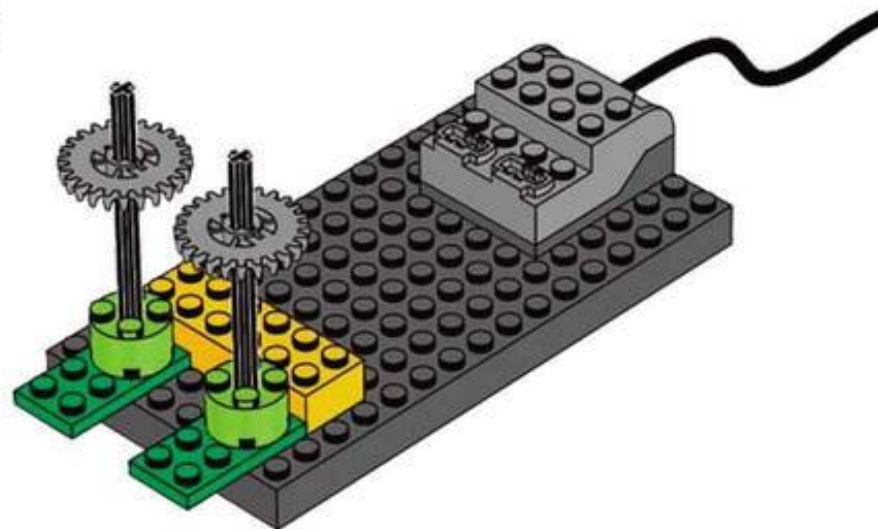

6

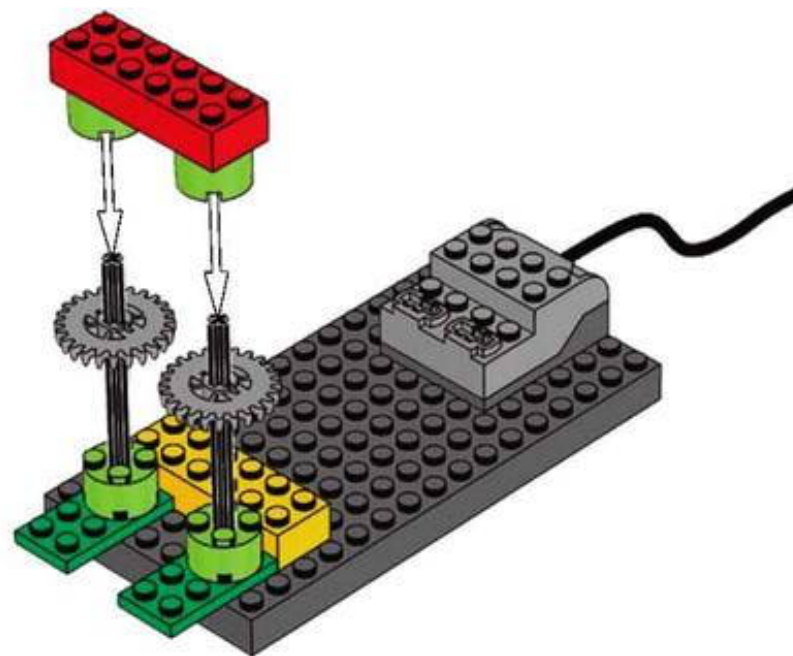

7

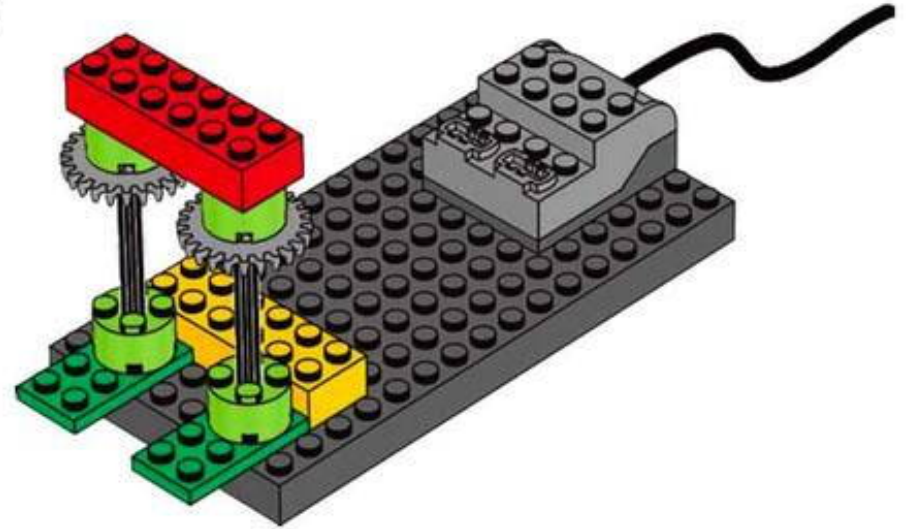

8

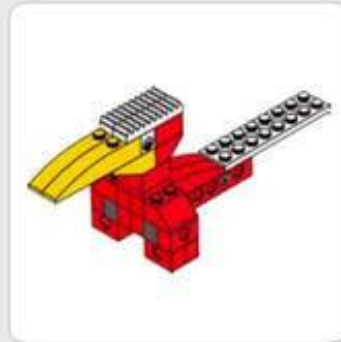

1 red beam
1 X 8

2 connector pegs
with friction



9

1 red beam
1 X 8



10

2 red curved beams
1 X 6



1 plate
2 X 8

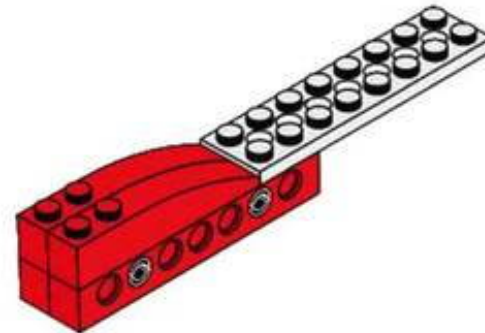

11

1 turntable
2 X 2
1 red brick
2 X 2

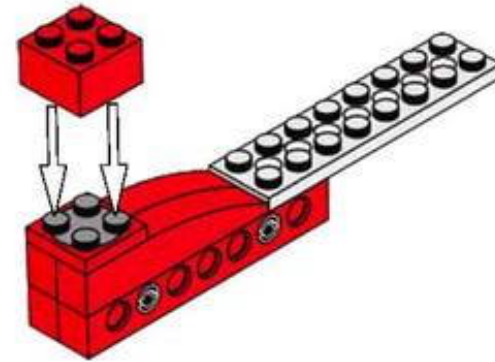

12

1 yellow roof brick, inverted
2 X 3
2 beams with eyes
1 X 1



13

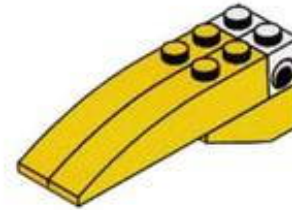

2 yellow curved beams
1 X 6



14

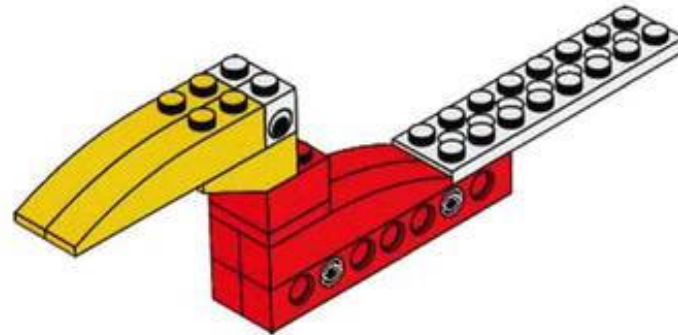

15

1 red roof brick, inverted
2 X 2

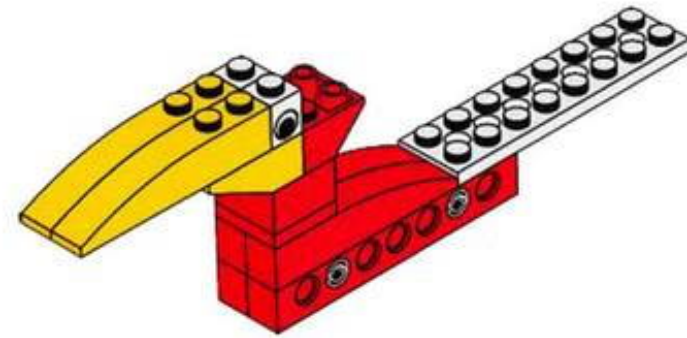

16

1 red brick
2 X 2

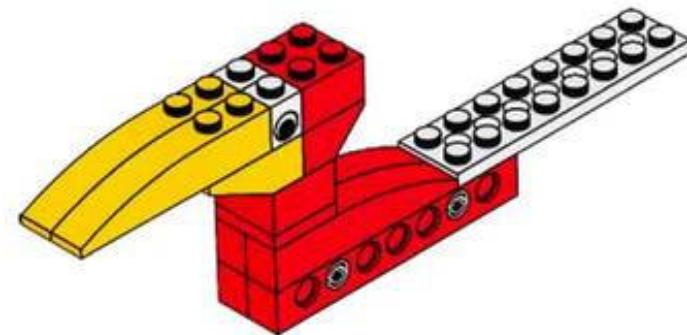

2 gear racks, 10-tooth



4 red beams
1 X 2



17

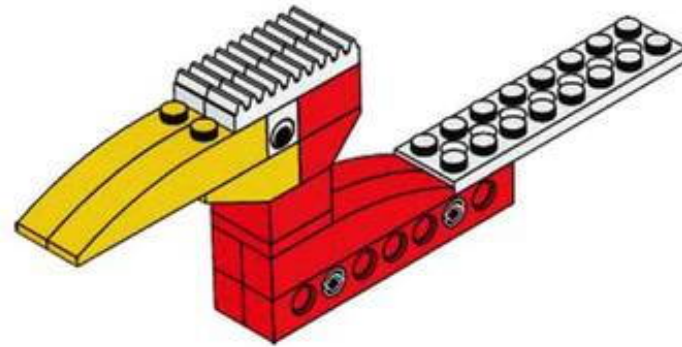

18



19



20



2 beams with connector pegs
1 X 2

2 red beams
1 X 2

2 red roof bricks
2 X 2

21

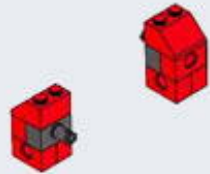
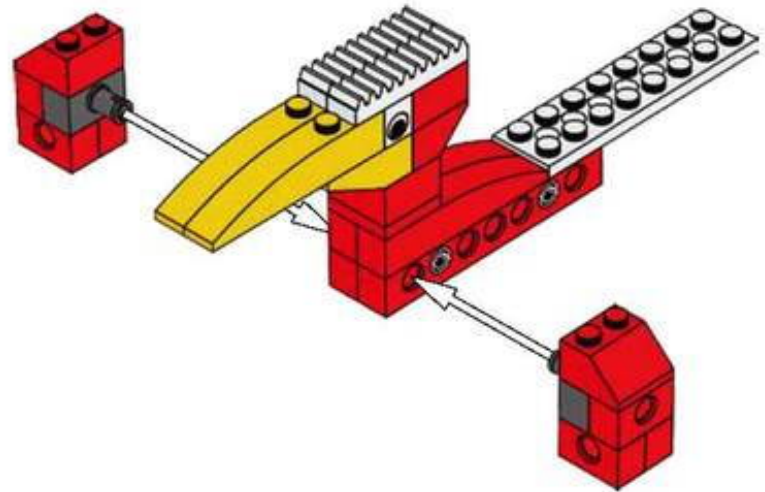

22

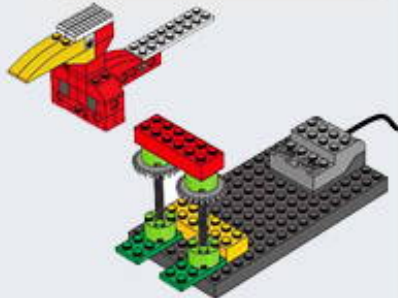
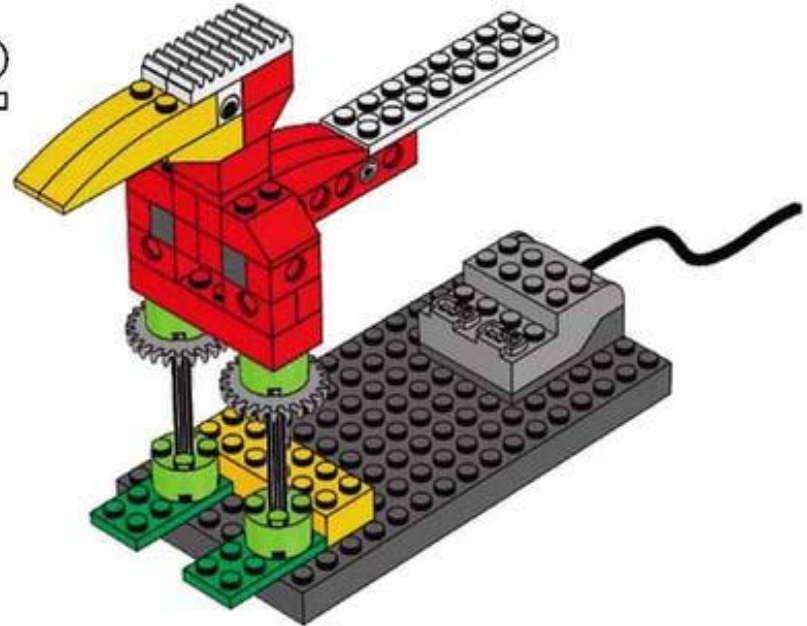



23

1 red beam
1 X 6



1 beam with connector peg
1 X 2

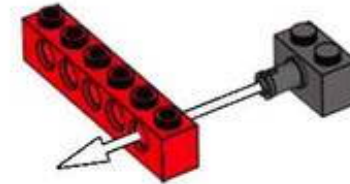

24

1 grey beam
1 x 2

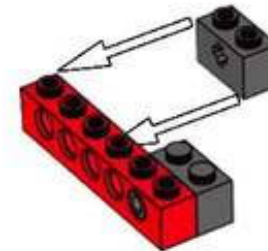

25

1 connector peg with axle

1 plate
2 X 8



26

1 axle, 6-module

1 wheel



27



1 plate
2 X 6



28



1 bushing



29

1 red beam
1 X 6
1 beam with connector peg
1 X 2

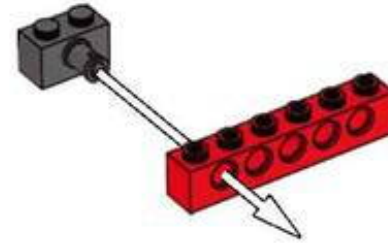

30

1 grey beam
1 X 2

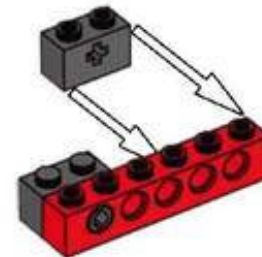

1 connector peg with axle
1 plate
2 X 8



31



1 axle, 6-module

1 wheel



32

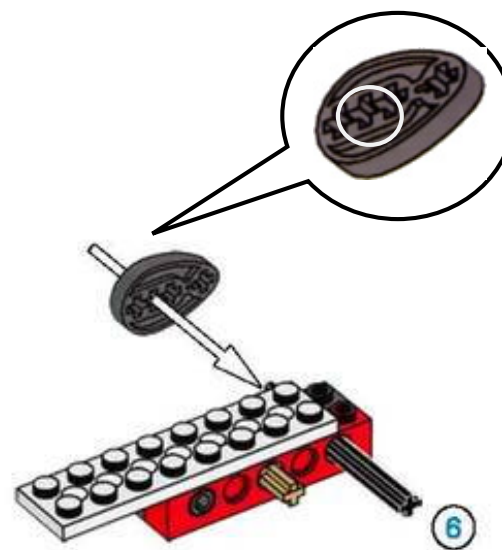

33

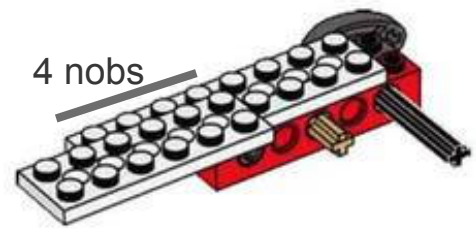

4 nobs

1 plate
2 X 6



34

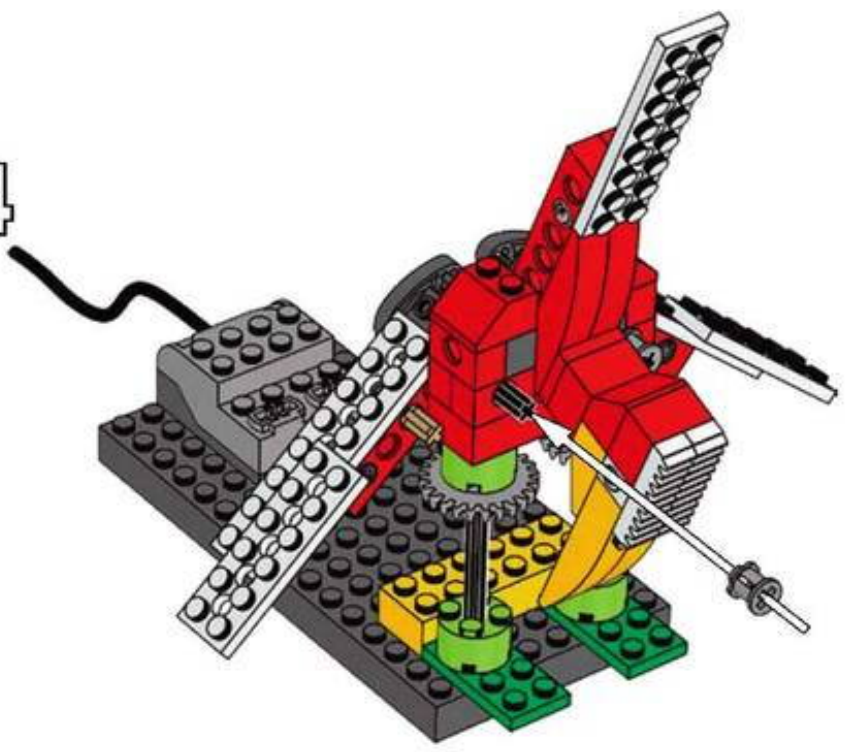

1 bushing



35

1 tilt sensor

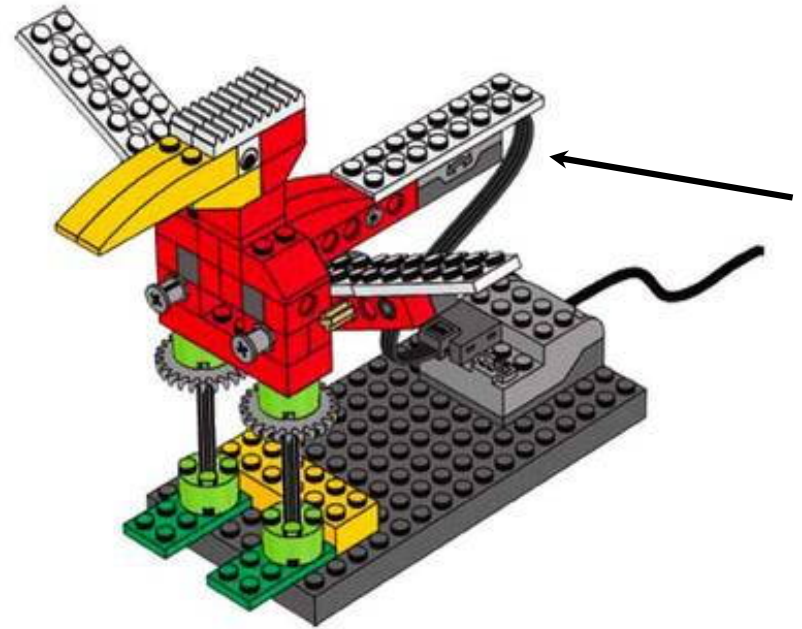

Well
done!