

The Kicker

Model 7

Source : Plan et images de LEGO Education
Modification et bonification des plans par le Service national du RÉCIT à l'éducation préscolaire
Translation: LEARN-RÉCIT
February 2011

The Kicker, Model 7

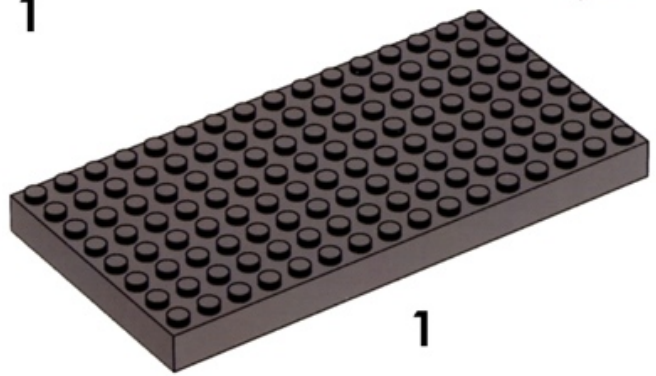
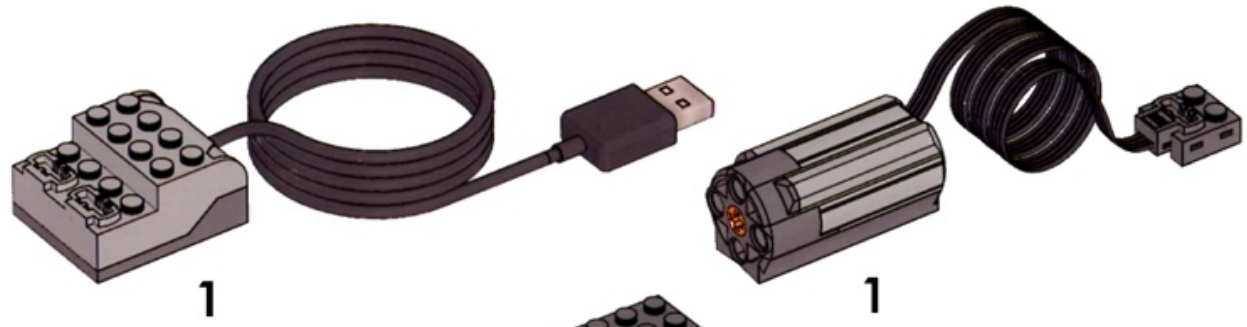
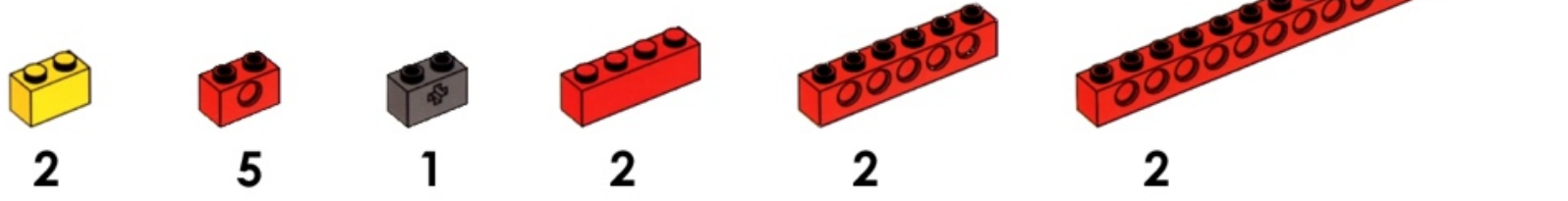
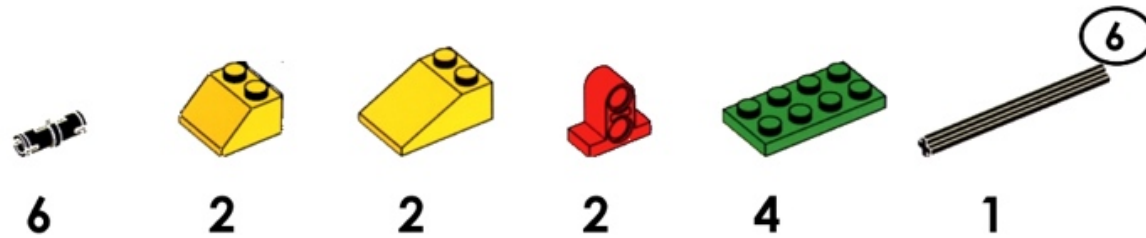



1 brick
8 X 16



1 USB hub



1 red beam
1 X 4



1

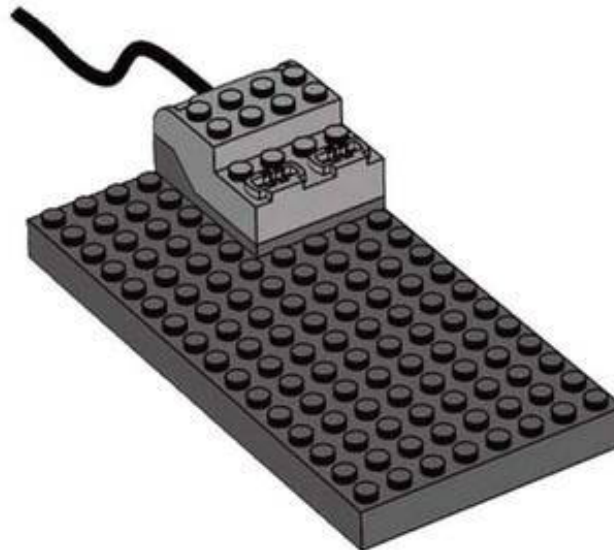

2

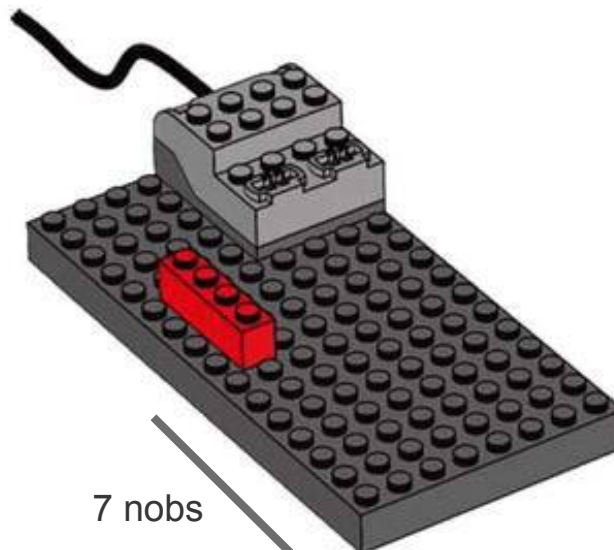

7 nobs

1 red beam
1 X 6



1 red beam
1 X 2

3

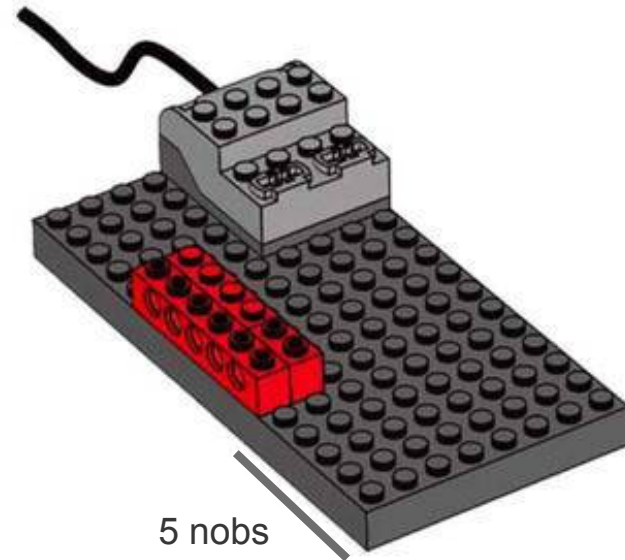

5 nobs

4

1 yellow roof beam
2 X 2



1 yellow beam
1 X 2

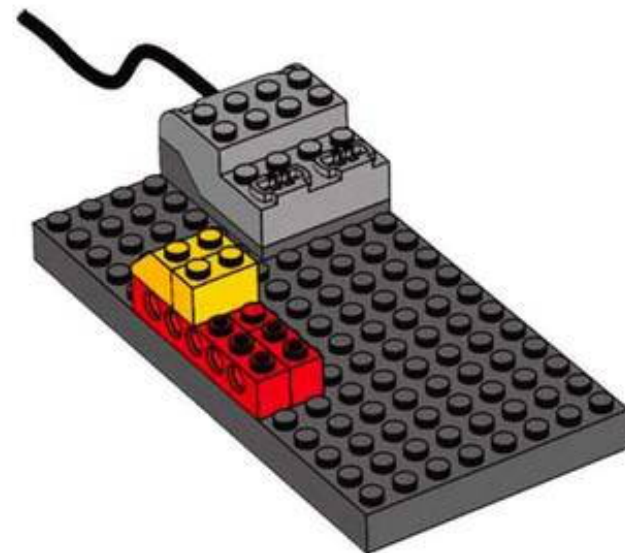

1 yellow roof beam
2 X 3



2 connector pegs with friction

5

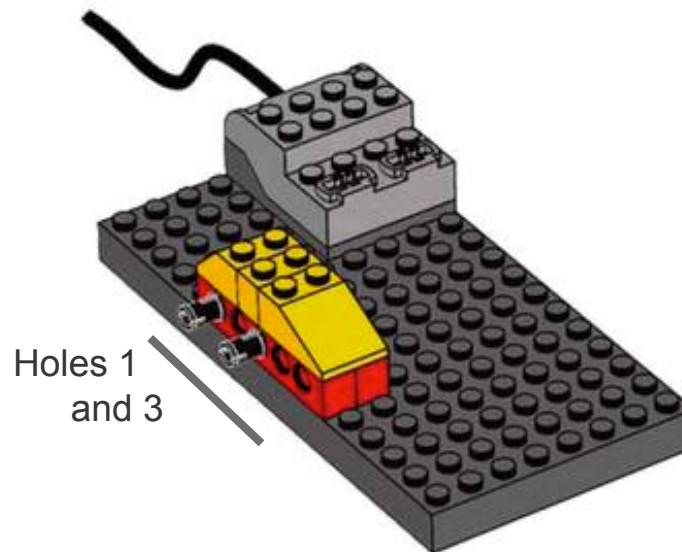

Holes 1
and 3

1 green plate
2 X 4



1 red beam
1 X 16

6



2 red beams
1 X 2



7

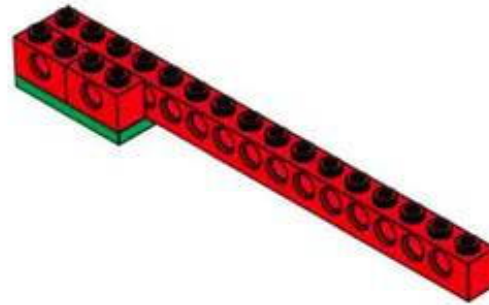

8

1 green plate
2 X 4



1 red beam with plate
2 module

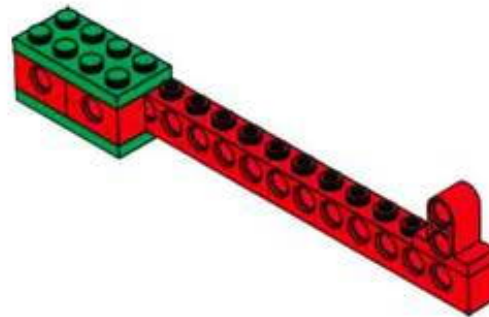

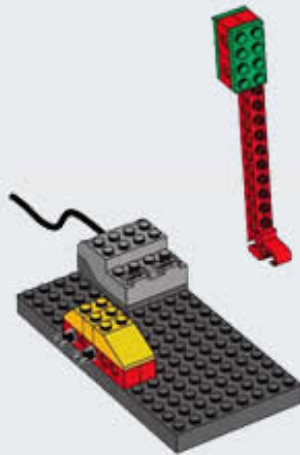

9

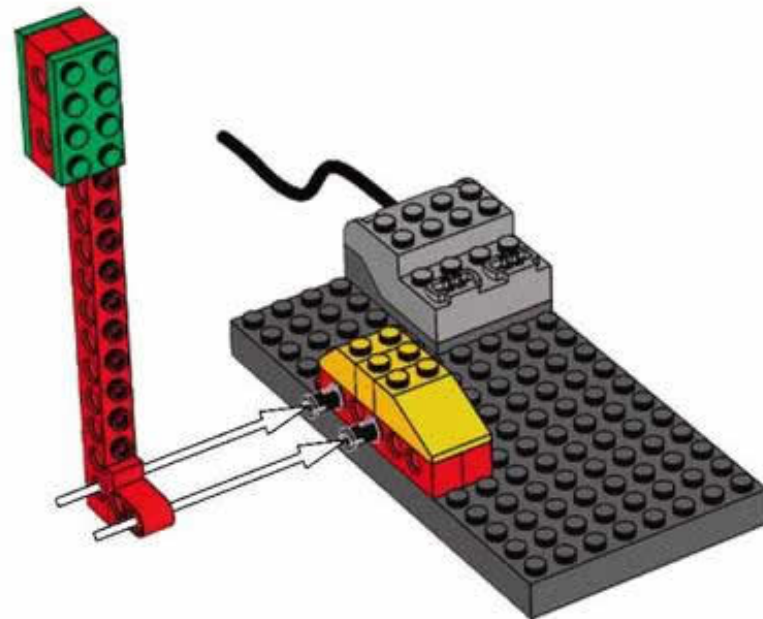

10



1 axe, 6-module

1 motor



11

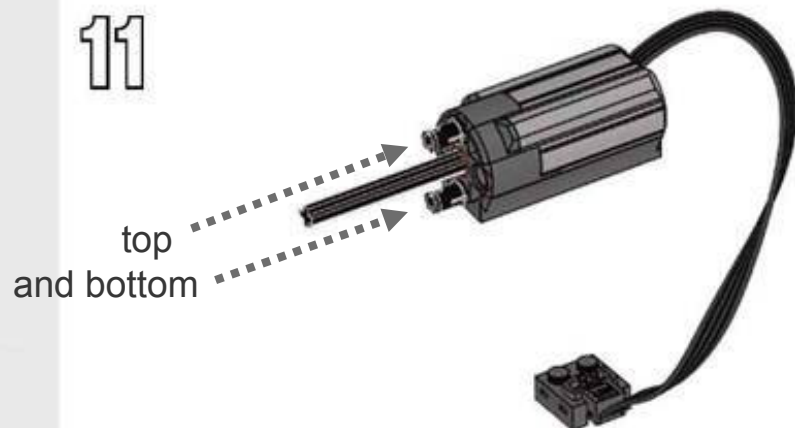

top
and bottom

12

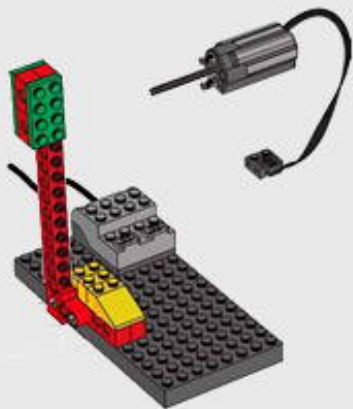
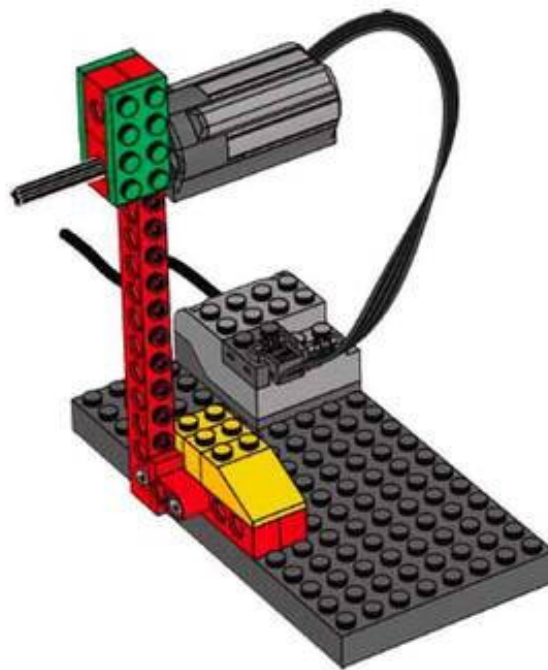

2 connector pegs with friction

13

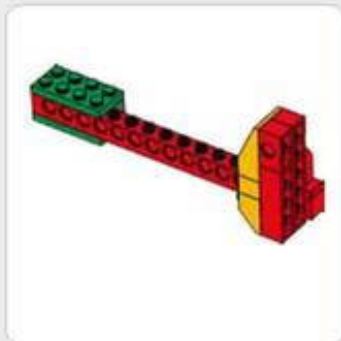

1 green plate 2 X 4

1 red beam 1 X 2

1 grey beam 1 X 2

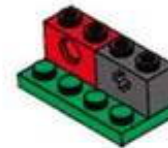

14

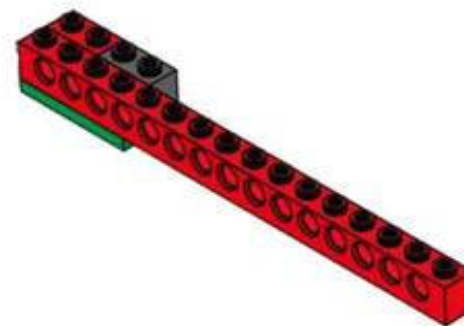

1 red beam
1 X 16



15

1 plate
2 X 4
1 beam with plate,
2-module

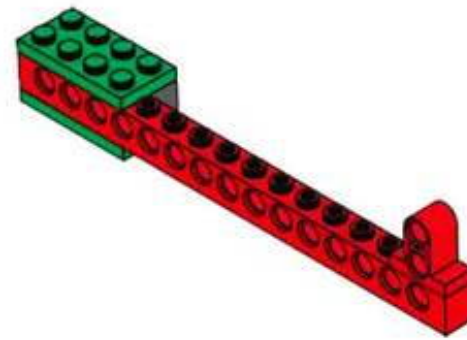

16

1 red beam
1 X 4
1 red beam
1 X 6

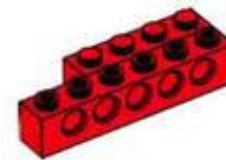

17

1 yellow roof brick
2 X 2

1 yellow beam
1 X 2

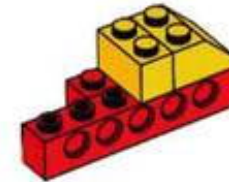

18

1 red beam
1 X 2

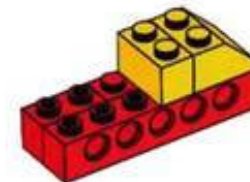

19

1 yellow roof brick
2 X 3

2 connector pegs with friction

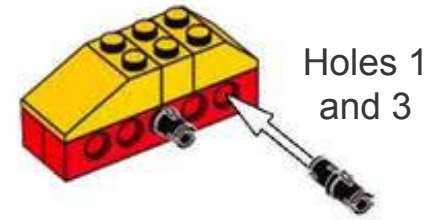

20

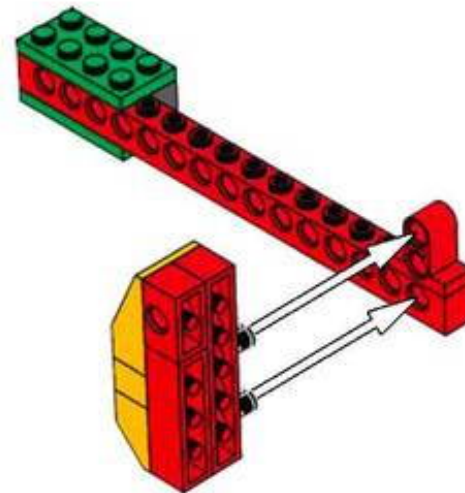

Well
done!



21

